



Royal Alloy

**Grand
Tourer 125**

**Grand
Prix 125**

OPERATION MANUAL

Preface

Thank you for choosing the Royal Alloy **GT125**, **GP125** scooter. Royal Alloy products embody high technology with reliability and have been designed utilising RA Engineering Co. Ltd and its partners' many years of experience in manufacturing motorcycles and scooter for travel, commuting, leisure and sporting activities.

This is why this model takes a leading position in the market sector. This manual explains the use, operation, basic inspection and maintenance etc for your scooter. If you have any further questions about the operation and maintenance, please contact your dealer.

The scooter is designed to fully meet the exhaust emissions standards prevailing on the date of manufacture.

To keep the compliance to the exhaust emissions standards, please carry out the maintenance schedule and instructions in this manual in cooperation with your dealer.

The following important information will appear in this manual:

Caution

Refers to procedures that must be followed. Otherwise, your personal safety may be endangered.

Note

Refers to procedures that must be followed to avoid damaging the scooter.

Warning

Refers to procedures that must be followed to avoid injury to you, or other persons or the scooter.

Note

This manual should be regarded as part of the scooter and should be always with the scooter, even when it is resold.

Note

Our company is working hard in improvement of product design and quality. This manual contains the latest product information at the time when it is printed. However, it is possible that the manual may have slight differences with your scooter. If you have any question, please contact your dealer.

Warning

Read this manual carefully before riding the scooter.

Contents

Contents	3
Precautions for Safe Riding	5
Names of different parts	6
The Serial Number	8
Functions of Controllers	9
Instrument Panel Indications	9
Ignition switch	133
Switches on the Handlebars	14
Throttle Grip	15
Brake Levers	15
Side Stand	16
Main Stand	16
Fuel Tank Cap	17
Seat Lock	17
Front Luggage Box	18
Fuel and Oil Recommendations	20
Running-in of New Scooter	21
Inspection before Riding	23
Battery connection	23
Inspection of Braking effect and free play	23
Inspection of the Tyre	24
Inspecting the Quantity of Fuel	24
Inspecting the Quantity of Engine Oil	25
Inspecting the Transmission Oil Level	26
Inspection of the Ignition Unit and the Lights	26
Inspecting the Rear View Mirrors	26
Inspecting the Reflectors and the License Plate	27
Riding Tips	28
Start the Engine	28

Setting off	28
Inspection and Maintenance	31
The First Service	31
Maintenance Schedule	32
Battery	34
Spark Plug	35
Fuel Hose	36
Air Filter	36
Throttle Cable Adjustment	37
Hydraulic brake fluid	37
Tyres	38
Fuse	39
Troubleshooting	40
Storage Procedures	40
Specifications	42
Warranty	43

Precautions for Safe Riding

Please obey all local traffic regulations and consider safety prior to riding. It is advised to control your speed to stay within safe limits.

Practice before Riding

Before riding the scooter in traffic, it is advised to practice your riding at a spacious and traffic-free place so that you are skilled enough to ride safely and are familiar with the scooter's controls. Practice is essential to safety. Please observe any special training and or government test required before using your scooter on public highways.

Knowing Your Safety Speed Limit

Safety speed limit varies in accordance with the road conditions, riding skill and the weather. To be aware of speed limits is helpful to avoid traffic accidents.

Be Careful on Rainy Days

It is dangerous to ride on damp or wet roads. Therefore, high speed should be avoided and special care should be taken when turning. Bear this in mind, the braking distance on rainy days can be twice as much as on dry days.

Correct Wearing of Safety Helmet

Always wear a safety helmet whenever you ride, and make sure you fasten the strap securely whenever you wear the helmet.

Safety clothing Recommendation

Bright-coloured and well-fitting clothes are recommended. Fitted with EC protection. Always wear gloves.

Indispensable Maintenance and inspection

The following items are indispensable:

- ◇ Make safety checks before every journey.
- ◇ Half-yearly thorough inspection.
- ◇ One-year thorough serving.
- ◇ Those listed in the Maintenance Schedule.

Caution High Temperature

The high temperature of the muffler may cause burns. Please park your scooter to prevent the accidental chance of persons coming into contact with the muffler.

No modifications allowable

Modification to the unit is prohibited as it may compromise safety of riding.

Names of different parts

Familiarise yourself with the following parts carefully before using the scooter.

① Exhaust / Muffler	② Rear light / brake light	③ Rear rack
④ Seat	⑤ Acceleration grip & right switch	⑥ Head lamp
⑦ Front turning lamps	⑧ Front right shock absorber	



⚠ Warning

Rear rack has a maximum payload of 5 kgs

① Rear brake lever	② Rear-view mirrors	③ Left grip switch
④ Glove box	⑤ Rear shock absorber	⑥ Rear turning lamps
⑦ Rear disc brake	⑧ Air filter	⑨ Rear Drive
⑩ Main stand	⑪ Side stand	⑫ Front disc brake
⑬ Front left shock absorber		



The Serial Number

Engine number

Engine number is stamped on the rear of the crankcase assembly.

Note:

Quote your chassis number for convenience in purchasing correct spare parts from your dealer.

Chassis number

Chassis number is stamped on the frame right side frame rail.

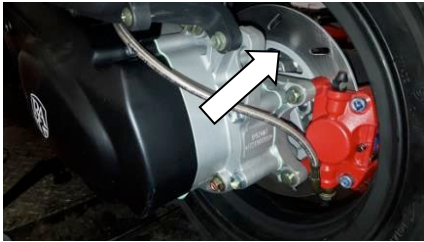

Engine number

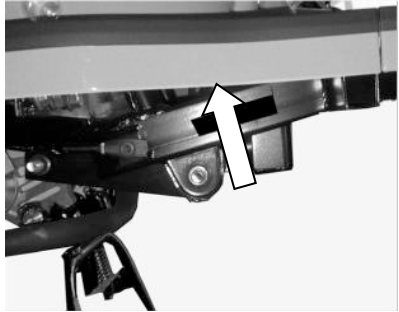

Chassis number

Please write down the serial numbers below for future reference.

Chassis Serial No. :

Engine Serial No. :

Functions of Controllers

Instrument Panel Indications(GT125/150)

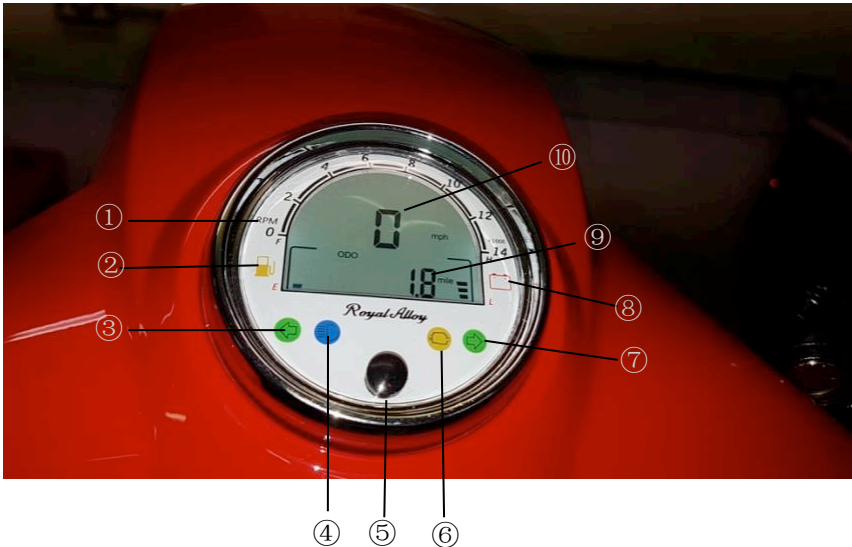

① Engine RPM Indicator

The indicator will show the engine RPM.

② Fuel gauge

Indicate the fuel volume remaining in the fuel tank. When the pointer points to “F”, the fuel tank is full. When the pointer moves to “E” or lower, it means the fuel level is low and urgent refilling is necessary.

③/⑦ Lh Direction Indicator & Rh Direction Indicator Lamps

When the left hand indicator is operated the l/h direction indicator lamp will flash. When the right hand indicator is operated the r/h direction lamp will flash.

④ High beam/ Low beam indicator.

⑤ “MODE” button, function see below.

- a. ODOMETER and TRIP METER change:
Insert the key and turn the ignition “ON” to display the ODO
press “MODE” once to change to the TRIP function.
- b. Km/h and mph change:
Depress the “MODE” button for 3 seconds to change between km/h
and mph.
- c. Clearing the trip counter history:
Press and hold for 5 seconds release when zero is displayed.

⑥ MI Indicator

If this warning light appears during riding, please consult your dealer.

⑧ Battery Indicator

Indicates the battery voltage. When the pointer points to “H”, the battery is full. When the pointer moves to “L” or lower, it means the battery voltage is low and charging is necessary.

⑨ Display ODO, Trip

Displays the distance - total or single that the scooter has been ridden.

⑩ Speedometer

The speedometer shows the speed at which you are riding in mph or km/h.

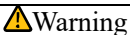

Warning

Before turning the ignition on for the first time, please ensure that the battery is fully charged and that the battery terminal connectors are secure.

Instrument Panel Indications(GP125/150)

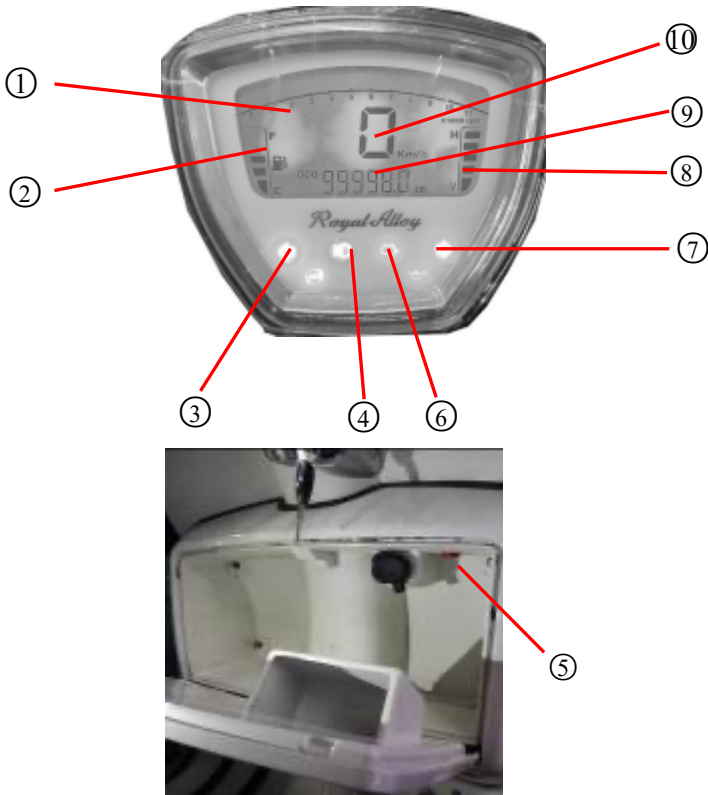

① Engine RPM Indicator

The indicator will show the engine RPM.

② Fuel gauge

Indicate the fuel volume remaining in the fuel tank. When the pointer points to “F”, the fuel tank is full. When the pointer moves to “E” or lower, it means the fuel level is low and urgent refilling is necessary.

③/⑦ Lh Direction Indicator & Rh Direction Indicator Lamps

When the left hand indicator is operated the l/h direction indicator lamp will flash. When the right hand indicator is operated the r/h direction lamp will flash.

④ **High beam/ Low beam indicator.**

⑤ **“MODE” button, function see below.**

ODOMETER to TRIP METER

TRIP METER to ODOMETER to change between displays:

- With the ignition key turned to the on position.
- Press the “MODE” button then release “MODE” button.
- Clearing the trip counter history – When the display is TRIP METER, press the “MODE” button and hold for 5 seconds then release when zero is displayed.

KPH to MPH

MPH to KPH change:

- When the display is ODOMETER, press the “MODE” button and hold for 5 seconds then release.

⑥ **MI Indicator**

If this warning light appears during riding, please consult your dealer.

⑧ **Battery Indicator**

Indicates the battery voltage. When the pointer points to “H”, the battery is full. When the pointer moves to “L” or lower, it means the battery voltage is low and charging is necessary.

⑨ **Display ODO, Trip**

Displays the distance - total or single that the scooter has been ridden.

⑩ **Speedometer**

The speedometer shows the speed at which you are riding in mph or km/h.

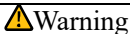

Warning

Before open the ignition switch, To prepare an adequate battery, and connected firmly, can not have any loose.

Ignition switch

Rotate the key to turn power ON or OFF.

ON	The engine can be started Possible to drive Not possible to pull out the key.
OFF	The engine cannot be started. The engine is stopped The key can be inserted or removed
LOCK	The steering bars can be locked to one direction. The key can be inserted or pulled out.

When you leave the scooter, you may lock the steering handlebars to help prevent your scooter from being stolen.

1. Turn the handlebars to the left.
2. Insert the key. Press the key in and turn it anti-clockwise to LOCK position.
3. Pull out the key.

To unlock the handlebars, insert the key from LOCK position, and turn it (without pressing) clockwise to OFF position.



Note

- ✧ Swing the handlebars to check if they are locked.
- ✧ Tip, you may turn the handlebars slightly rightward and try again.

Switches on the Handlebars

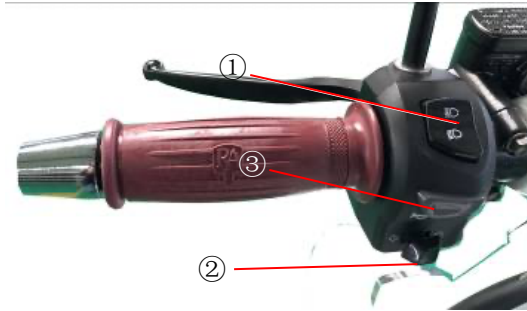

① Beam Switch

This switch is used to change the headlamp beam. When you turn the switch to:

HIGH	The high beam is turned on.
LOW	The low beam is turned on. (Low beam is for normal riding)

② Turning Signal Lamp Switch

This switch is used to turn on and off the left or right signal lamps to show the other vehicles that you want to turn left or right. When you turn the lever to:

Right	The right signal lamps flash.
Left	The left signal lamps flash.
Centre	Push in the switch at the centre position to cancel the turn-signal operation.

Please turn off the lamps when they are no longer necessary, otherwise you may cause problems to other road users

③ Horn Button

Press this button to sound the horn. The horn is used as a warning.

④ Starter Button

This button is used to start the engine. Turn the ignition key to ON, squeeze the rear brake lever and press the button.

The rear brake lever must be applied to allow the starter motor to engage as a safety function



Throttle Grip ⑤

Throttle grip is used to control engine speed. Turn it towards (anticlockwise) you to increase engine speed; Turn it away from you to decrease the engine speed.

Brake Levers ⑥

By operating the brake levers, you can control the speed of the scooter to slow down or stop. The brake is applied by squeezing the brake lever gently towards the grip. The rear brake light will be illuminated when the front or rear brake lever is squeezed inwards.



Side Stand ⑦

To use the side stand, depress the end of the stand until it rotates towards the front of the scooter and stops. Please note: If the side stand is not fully retracted the engine will not start.

Main Stand ⑧

To use the main stand, depress it by foot until the stand is touching the floor and lift the rear of the scooter backwards until the stand is securely in place with the rear wheel off the ground. Use the rear rack to assist in lifting the scooter upwards and backwards.

Always ensure that the scooter is on level ground or pointing uphill on hard standing before putting the scooter on the main stand.

Never put the scooter on the stand if the machine is pointing downhill or the floor is uneven or on soft or loose ground.

Please Note

The main stand is designed to support the weight of the scooter only. It is not designed to support the weight of the scooter and a rider or passenger. This may damage the scooter and/or the main stand.
--

Fuel Tank Cap

To access the fuel cap open up the seat .To open the fuel cap, insert the ignition key into the cap and turn the fuel cap tab clockwise. Please note: Don’ t use the key to rotate the cap as this make cause the key to break, shuold the key and lock cover were rotated at the same time. Close the fuel cap use the same way.

There has a Operation Notice decal nerrby the fuel cap.

Operation Notice

When the key is inserted,the oil fillingport can be opened or closed unless the key and lock cover were rotated at the same time.

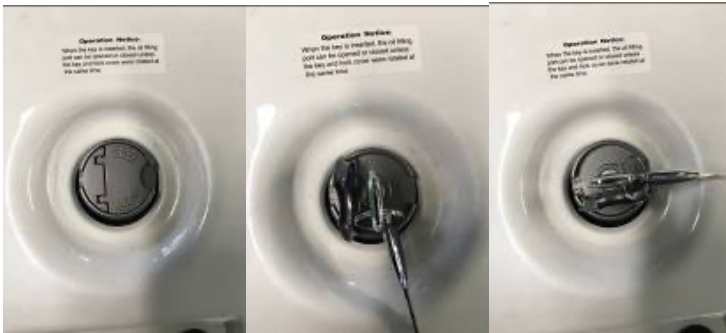

Seat Lock(一)



To open and close the seat as follows:

1. The seat release button is located on the left hand side and to the rear of the seat, push the button in and the seat will open.
2. To close the seat gently lower the seat down onto the locking pin.

Seat Lock(二)



To open the seat as follows:

Carefully lift the rear of the front seat with your hands, the seat will lift open.

To close the seat as follows:

Carefully push down the rear of the seat, the seat is secured to the centre section² by the sucker^φ, the seat will be locked.

Please Note

Please do not drop the seat to close it as this will damage the seat catch.

Front Luggage Box (GT125/150)

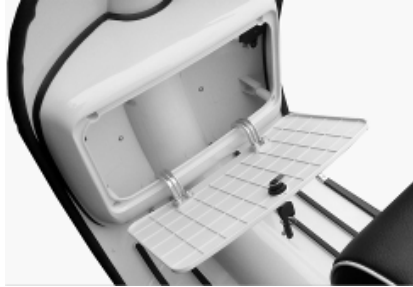

Front Luggage Box (GP125/150)



Caution

- ◇ Do not keep breakables in the luggage box.
- ◇ Do not keep valuable item in the luggage box.
- ◇ Do not place fuel and oil in the luggage box.
- ◇ Only store water proof items in luggage box
- ◇ Never forget to lock the luggage box.
- ◇ Maximum payload is 5 Kgs in the luggage box.
- ◇ Maximum payload is 5 Kgs for the rear luggage rack.

Fuel and Oil Recommendations

Fuel

Only use unleaded fuel with an octane number 90 or higher. Unleaded fuel can extend spark plug life and exhaust component life.

Use of leaded fuel or lead additive will damage the catalytic convertor in the exhaust.

Engine Oil

Use only a high quality 4-stroke semi-synthetic engine oil, this will extend the longevity of the engine. Grade SE or SD engine oil in API method are recommended with a viscosity of SAE10W-40. If this oil is not available, please purchase appropriate substitutes according to the data listed below.

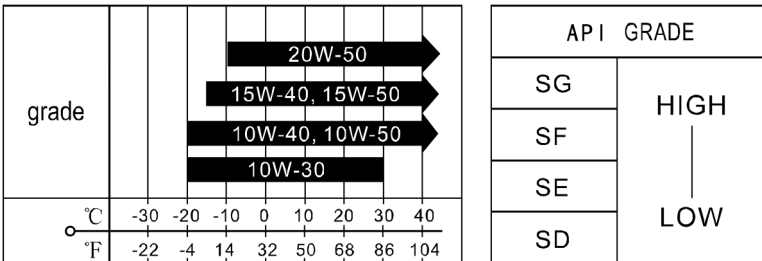

Transmission Oil

Use good quality EP 80w-90 gear oil.

Running-in of New Scooter

The first 500 miles are the most important in the life of your scooter. Proper running-in operation during this period will help ensure maximum life and performance from your new scooter. The parts are manufactured of high quality materials, and machined parts are finished to close tolerances. Correct running-in procedure allows the machined surfaces to bed in and run smoothly. Freeing up of the internal parts is achieved after approximately 60 running hours, and during this running-in period the engine will loosen up and performance will improve.

Maximum Throttle Operation Recommendation

This table shows the maximum recommended throttle operation during the running-in period.

Initial 500 miles	Less than 1/2 throttle
Initial 1000 miles	Less than 3/4 throttle

Vary the engine Speed

The engine speed should be varied and not held at a constant speed. This allows the parts to be “loaded” with pressure, and then unloaded, allowing the parts to cool. This aids the running-in process of the parts. It is essential that some load should be placed on the engine components during running-in. Keep the engine spinning but do not place excessive loads on the engine.

Avoiding Constant Low Speed

It is not beneficial when running in the engine to operate it at a constant low speed. Allow the engine to accelerate freely within the recommended maximum limits. Do not, however, use full throttle for the first 1000 miles.

Allow the Engine Oil to Circulate before Riding

Allow sufficient idling time after warm or cold engine start up before applying load or revving up the engine. This allows time for the lubricating oil to reach all critical engine components. Failure to do this will shorten the life of your engine.

Performing the First Service

The first 500Km service is the most important service your scooter will receive. During running-in all of the engine components will have bedded in and all the other parts will have seated in. All adjustments will be restored, all fasteners will be tightened, and the old oil will be replaced.

Timely performance of the 500Km service will ensure optimum service life and performance from the engine.

 Caution
--

<p>The 500Km service should be performed as outlined in the inspection and maintenance section in this manual. Pay attention to the caution and warning in that section.</p>
--

<p>Failure to have your Royal Alloy scooter serviced will void the warranty.</p>
--

Inspection before Riding

Before riding the scooter, be sure to check the following items. Never underestimate the importance of these checks. Perform all of them before riding the machine.

 Warning

Ensure that the battery is fully charged and that the battery is secure and the battery terminals/connectors are secure. A battery with loose connections will damage electrical components including the ecu.

WHAT TO CHECK	CHECK FOR
Steering	<ol style="list-style-type: none"> 1) Smoothness 2) No restriction of movement 3) No play or excessive movement
Brakes	<ol style="list-style-type: none"> 1) Correct brake lever free play 2) No obstruction in braking.
Tyres	<ol style="list-style-type: none"> 1) Correct pressure 2) Adequate tread depth 3) No cracks or cuts
Fuel	Enough fuel for the planned distance of the journey
Lighting	Operate all lights —headlamp, tail lamp, brake lamp, turning lamps
Indicators	Oil indicator (if fitted) and turning indicators
Horn	Correct function
Engine oil	Correct level
Throttle	<ol style="list-style-type: none"> 1) Correct play in the throttle cable 2) Smooth operation and positive return of the throttle grip to the closed position when released

Inspection of braking effect and free play

Hold the brake levers until feeling resistance, measure the moved distances at the lever ends. The distances should be 10~20mm.

Inspection of the Tyre

1. Tyre Pressure

Observe the wear condition of the tyre and check the tyre pressures. If the tyre pressure is abnormal, check it with a tyre pressure gauge and adjust it to the correct value.

Recommended Tyre Pressure

Front Wheel	32psi
Rear Wheel	34psi

2. Crack, Damage, Foreign Object and Abnormal Wear

Check the surface of the tyre:

- ◇ Is there any obvious damage?
- ◇ Are there any nails, stones, glass etc. in the tyre or in the tread?
- ◇ Is there any abnormal wear?

Inspecting the Quantity of Fuel

Make sure that there is enough fuel to reach your destination. Turn the ignition switch to ON position, if the fuel gauge hands points to the red region, the fuel should be refilled as soon as possible.

Inspecting the Quantity of Engine Oil

Caution! Always ensure the oil level is kept at the upper level mark “B”. Never allow the oil level to exceed the upper mark or fall below the lower mark “C” this will cause severe engine damage. It is the rider’s responsibility to ensure that the engine has enough oil.

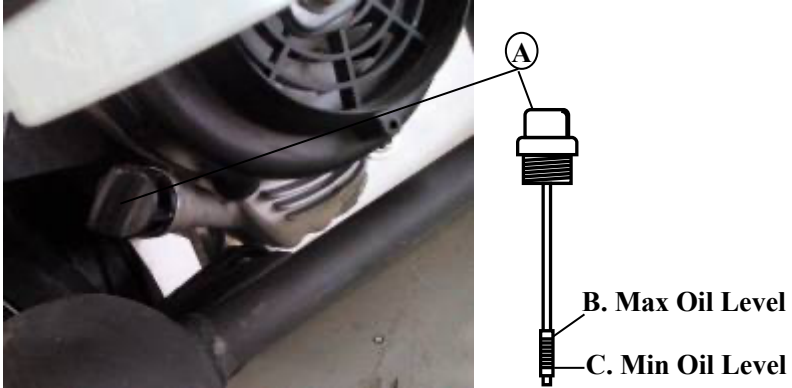

1. Keep the vehicle in an upright and level position on the main stand.
2. Start the engine, let it idle for a few minutes to allow the oil to circulate and then switch it off.
3. Wait for five minutes to allow the oil to return to the crankcase and settle.
4. Loosen the refilling oil cap/dipstick and remove.
5. Clean the dipstick of oil residues, insert the oil filler cap but don't screw it in, otherwise there will be a wrong measurement which may lead to engine damage. Remove again and check for the correct oil level it must be between the reference marks “B” and “C”.
6. If necessary, fill to the “B” level, taking into account that it should not exceed the “B” mark.
7. Refit the dipstick securely

Inspecting the Transmission Oil Level

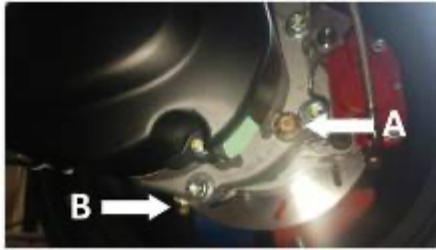

1. Start the engine, let it idle for a few minutes to allow the oil to circulate and then switch it off. Wait for 5 minutes before checking the oil level.
2. Remove the oil filler screw (A) and check that the oil level is just below the oil-filler opening.
3. If required, replenish transmission oil Hypoid EP 80W - 90 via the oil-filler opening.
4. When changing transmission oil, open the drain plug (B) until all transmission oil flows out then tighten the plug (B) and add new oil via the oil-filler opening.
5. Tighten the oil filler screw (A).

Inspection of the Ignition Unit and the Lights

Start the engine, check if the headlight and the rear light are on.

Operate the front and rear brake separately, and check if the brake light is activated.

Operate turning signal lamp switch, and check if the turn signal lights work normally.

Inspecting the Rear View Mirrors

Check if the back and side objects can be seen clearly from the rear view mirrors when seated in the rider's position.

Check if the rear mirror is clean and free from damaged check tightness on the handlebar mounting.

Inspecting the Reflectors and the License Plate

Check that the license plate and the reflectors are not dirty or damaged.

Check that the license plate is fixed securely and that the registration number is clearly visible.

Riding Tips

Caution

Before starting, you must

1. Check the quantity of fuel and engine oil.
2. Place the scooter onto the main stand.
3. Ensure that the machine is on flat, hard ground.
4. Apply brakes

Start the Engine

Insert the ignition key into the ignition switch and turn it to ON

When the engine is cold:

5. Squeeze the rear or front brake lever and hold the throttle 1/8-1/4 turn open.
6. Push the starter button until the engine fires.
7. Hold the throttle at 1/8-1/4 open for 30 seconds to help the engine warm and to prevent the engine from stalling.

When the engine is warm:

8. Squeeze the rear or front brake lever.
9. Open the throttle 1/8~1/4.
10. Push the starter button until the engine fires.

Caution

Release the starter button soon after the engine is started. Otherwise damage may result to the starter motor and gear wheels.

Setting off

- a) Take the scooter off the main stand.
- b) Mount the scooter.

While holding the handlebars with both hands, and both brakes applied mount the scooter from left side and sit on the seat. Support yourself with your left foot.

 Caution

No turning of the throttle grip is advised before you are ready to set off.

- c) Look around to see if it's safe to set off.

Activate your turning indicator. Look around to judge the conditions are safe to set off. Keeping the rear brake lever squeezed until you are ready to set off.

 Caution

Special attention should be paid to the traffic approaching you from behind.

- d) Setting off

Release the rear brake lever and gradually rotate the throttle grip to let the scooter build up speed.

 Caution

Excessive rotation of the grip can lead to the danger of sudden acceleration.

- e) Adjust Speed

The speed of your scooter can be adjusted by turning the throttle grip. Rotate the grip towards you to speed up (anti clockwise). Gradual rotation is recommended. Close the throttle to slow down.

- f) Applying the Brakes and Stopping

Combined application of both brakes is always recommended.

Quickly release the throttle grip or rotate backwards (clockwise) to the minimum position and squeeze the brake levers simultaneously.

It is advisable to reduce the speed by gradual application of the brakes.

Take extra care when riding on damp or wet roads.

 Caution

Heavy single braking of the front or rear wheel may cause the danger of a skid.

Harsh braking or sharp turning are one of the major causes for loss of traction or crashes, and should therefore be avoided.

Special care should be taken in rainy and wintery conditions.

Damp or wet road surfaces may reduce the level of grip. Sharp turning during acceleration should be avoided. An appropriate distance should be kept from the vehicles ahead. Please be mindful that the braking distance on rainy days can be twice as much as on dry days.

Skidding may occur on wet or frozen roads, therefore concentrate and be ready to apply the brakes cautiously at any time.

Check the brakes after washing the scooter or riding through water.

After washing the scooter or riding through standing water, the braking effect may be reduced. If this occurs, slow riding and gentle braking should be observed to allow time for the brakes to restore to their normal function.

 **Caution**

To prevent your scooter from falling off the main stand never park your scooter facing downhill or on a loose or soft surface.
Always park the scooter on a hard flat surface or facing uphill.

Lock the handle bar

When you park the scooter, lock the handle bar to help protect your scooter from theft.

Inspection and Maintenance

The maintenance schedule indicates the intervals between periodic services in Kms and months. At the end of each interval, be sure to inspect, check, lubricate and service as instructed. If your scooter is used under heavy load conditions such as continuous full throttle operation or is operated in a dusty climate, certain services should be performed more often to ensure reliability of the machine as explained in the maintenance section. The dealer can provide you with further guidelines. Steering components, suspension and wheel components are key items and require very special and careful servicing. For maximum safety we suggest that you have these items inspected and serviced by your dealer or a qualified service mechanic.

The First Service

The maintenance after the first 500 Kms is the most important. During running in, all engine parts will have been matched to each other, bedding in will have occurred with other parts. All parts should be re-adjusted; all fasteners re-tightened and contaminated engine oil and filters replaced.

To ensure the engine a long service life and optimum performance, carry out the 500 Kms service as soon as it is due.

Caution

We suggest you use genuine replacement parts. We recommend that those items on the maintenance schedule marked with an asterisk (*), be performed by the authorized dealer. You may perform the unmarked items easily by referring to the instructions in this section.

Failure to have your Royal Alloy scooter serviced in accordance with the manufacturers stipulations will void your warranty cover.

Maintenance Schedule

The table below indicates the most important aspects which should be carried out per service.

	600 miles (1000 km)	3700 miles (6000 km)	7400 miles (12000 km)	11200 miles (18000 km)	14800 miles (24000 km)	18600 miles (30000 km)	22300 miles (36000 km)	26000 miles (42000 km)	29800 miles (48000 km)	33500 miles (54000 km)	37300 miles (60000 km)
Torque driver pins			L		L		L		L		L
Safety fasteners	I		I		I		I		I		I
Plastic sliders in variator cover			R		R		R		R		R
Clutch bell		C	C	C	C	C	C	C	C	C	C
Spark plug			R		R		R		R		R
Driving belt			R		R		R		R		R
Throttle control	A		A		A		A		A		A
Air filter		C	C	C	C	C	C	C	C	C	C
Transmission cover air duct filter			I		I		I		I		I
Engine oil filter	R		R		R		R		R		R
Valve clearance			A		A		A		A		A
Braking systems	I	I	I	I	I	I	I	I	I	I	I
Electrical system and battery	I		I		I		I		I		I
Brake fluid **	I		I		I		I		I		I
Gear oil	R		I		R		I		R		I
Engine oil*	R	I	R	I	R	I	R	I	R	I	R
Headlight aiming adjustment			A		A		A		A		A
Variator rollers			R		R		R		R		R
Vehicle road test	I		I		I		I		I		I
Variator front movable half-pulley			I		I		I		I		I
Radiator	I/C	I/C	I/C	I/C	I/C	I/C	I/C	I/C	I/C	I/C	I/C
Wheels/tyres	I	I	I	I	I	I	I	I	I	I	I
Suspension			I		I		I		I		I
Steering	I		I		I		I		I		I
Transmission			L		L		L		L		L
Fuel pipes ***	I		I		I		I		I		I
Anti-dive linkage bearings	I	I	I	I	R	I	I	I	I	R	I

NOTE: I=Inspect, clean, adjust, lubricate or replace if necessary
 C=Clean, R=Replace, T=Tighten

Bolts and nuts on frame body

Tighten the bolts and nuts to specified torque after initial 500 kms and every 3000 kms (6 months).

Specified torque settings

No.	Item	N·m	kg·m	Ft-lbs
1	Front axle nut	53	5.3	40
2	Handlebar mounting bolt	49	4.9	36
3	Steering stem lock nut	30	3.0	22
4	Handlebar locating bolt	25	2.5	18
5	Front fork mounting bolt	45	4.5	33
6	Master cylinder mounting bolt	10	1.0	7.5
7	Brake hose union bolt	23	2.3	17
8	Brake caliper mounting bolt	26	2.6	19
9	Brake bleed nipple	7.5	0.75	5.5
10	Front panel bolt	23	2.3	17
11	Rear axle nut	120	12.0	88
12	Rear shock bolt	29	2.9	21
13	Rear brake lever nut	11	1.1	8
14	Engine bracket mounting bolt/nut	98	9.8	72
15	Engine mounting bolt/nut	80	8.0	59

Battery



The battery is located inside the removable cover on the body centre cover beneath the front of the seat. This battery is a sealed type and requires no maintenance such as fluid level and gravity.

 **Caution**

If the machine is not being used for 2 weeks or longer – ensure the battery is kept fully charged by connecting the battery to a trickle charger.

Spark Plug

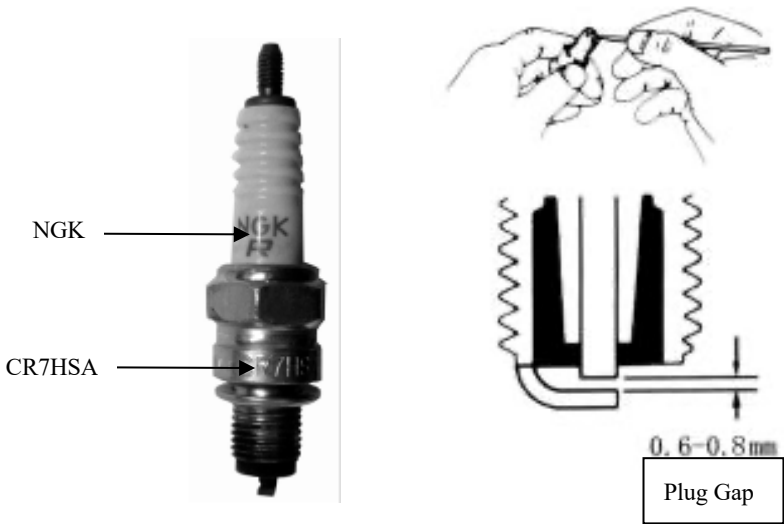

Use a small brass brush or cleaner to remove the carbon deposits at the first 500 Kms or every 3000 Kms. Re-adjust the spark plug gap with a spark plug gap thickness gauge to keep it 0.6~0.8mm. After every 6000 Kms, the spark plug should be replaced.

Whenever removing the carbon deposits, be sure to observe the colour of the spark plug porcelain tip. The colour of the tip can tell you whether or not the standard spark plug is suitable for your type of usage - this is assuming that everything else is running correctly. If the standard spark plug is very black, usage may be due to very short trips where the engine does not reach full operating temperature, you are better using a hotter heat range of spark plug. A normal operating spark plug should be light brown or tan in colour. If the colour is white, it then it may be due to overheating or a lean fuel mixture condition and should be checked as soon as possible by an authorised dealer.

 **Caution**

Don't over tighten the spark plug or cross thread it. In order not to damage the cylinder head, do not allow the contamination to enter the engine through spark plug hole.

The standard spark plug for this scooter has been carefully selected to meet the vast majority of all operation ranges. If the spark plug colour indicates that other than standard spark plug should be used, it is best to consult the dealer before selecting an alternate plug or heat range. The selection of an improper spark plug can lead to severe engine damage.

Fuel Hose

Replace the fuel hoses every two years.

Air Filter

The air filter element used in this scooter is a paper element type with a foam outer jacket. If the filter element has become clogged with dust, intake resistance will increase with a resultant decrease in power output and increase in fuel consumption due to the richer mixture. Check and clean the air filter element according to the following procedure.

1. Remove the screws.
2. Remove the two fixing slippers by sliding them rearward.
3. Remove the air filter cover.
4. Remove the filter element.
5. Clean the filter element by blowing it through with compressed air.

Clean every 1000 Kms and replace every 6000 Kms

 **Caution**

1. Before and during the cleaning operation, carefully examine the air filter element for any tears in the material. A torn filter element must be replaced with a new one.
2. If driving under dusty conditions, the filter element must be cleaned more frequently.
3. NEVER OPERATE ENGINE WITHOUT THE FILTER ELEMENT.
4. Always be sure that the filter element is in excellent operational condition at all times. The life of the engine depends largely on this very important individual component.

Throttle Cable Adjustment

1. Loosen the lock nut.
2. Adjust the cable slack by turning adjuster in or out to obtain the correct amount of free play 0.5~1.0mm.
3. After adjusting the free play, re-tighten the lock nut.

Hydraulic brake fluid

For front and rear disk brake model

Grade: DOT4.1

Note:

Only DOT4.1 glycol-based hydraulic brake fluid must be used in this scooter.

Do Not mix it with silicon-based or mineral oil-based fluid.

Otherwise the hydraulic brake system will be damaged and the performance of the braking system seriously reduced.

Don't use residual fluid from an opened container from previous maintenance, brake fluid is hygroscopic, it can absorb moisture from the atmosphere.

Caution

Do not over fill the master cylinder reservoirs or spill brake fluid onto any painted surfaces.

Brake fluid will damage your paint work.

Tyres

Before every ride check the tyre inflation pressure and tyre tread condition. For maximum safety and optimum tyre life, the tyre pressures should be inspected on a regular basis particularly before long journeys or with passengers.

Tyre Pressure

Insufficient air pressure in the tyres not only increases tyre wear but also seriously affects the stability of the scooter. Under inflated tyres make smooth cornering difficult and over inflated tyres decrease the amount of tyre in contact with the ground, which can lead to skids and loss of control. Be sure that the tyre pressure is within the specified limits at all times.

Tyre pressure should only be adjusted when the tyres are cold.

Cold Inflation Tyre Pressure

Front Wheel	32psi
Rear Wheel	34psi

Caution

Tyre pressures and the condition of your tyres are extremely important to the proper performance and safety of your scooter. Check your tyres frequently for both wear and correct inflation pressures.

Tyre Tread Condition

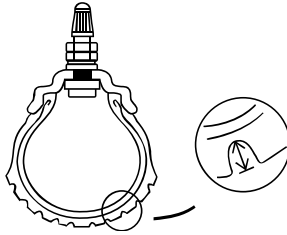

Operating the scooter with excessively worn tyres will decrease riding stability and can lead to loss of control. It is recommended that a tyre be replaced when the remaining depth of tyre tread becomes 1.6mm or less.

Caution

The standard tyres on your scooter are 110/70/12 front and 120/70/12 rear. The use of a larger tyre other than standard may result in clearance issues and may void your warranty.

Fuse

The fuse is located next to the battery. If there is any electrical system failure, first check the fuse. In case the fuse blows, there is a 10A spare fuse supplied in the fuse holder.

Caution

Always be sure to replace the blown fuse with the correct amperage fuse. Never use a substitute, for example aluminium foil or wire, to replace a blown fuse. If the spare fuse installed blows in a short period of time, it means that you could have a major electrical problem. You should consult the dealer or a qualified service mechanic immediately.

Troubleshooting

Caution

It is best to consult the dealer before attempting to troubleshoot any problem. If the machine is still within the warranty, then the dealer should definitely be consulted before you attempt any repairs on the machine. Tampering with the machine by yourself while in warranty may affect warranty consideration and void your warranty cover.

Storage Procedures

If the motorcycle is to be left unused for an extended period of time for winter storage or any other reason, the machine needs special servicing requiring appropriate materials, equipment and skill.

For this reason, we recommend that you trust this maintenance work to the dealer. If you need to service the machine for storage yourself, follow the general guidelines below.

Scooter

Place the motorcycle on its main stand and thoroughly clean the entire scooter.

Fuel

Drain the fuel tank and run the engine for a few minutes until the remaining fuel has been consumed.

Battery

Remove the battery from the scooter.

Clean the outside of the battery with mild detergent and remove any corrosion from the terminals and wiring harness connections.

Store the battery in a room above freezing and connect it to a suitable battery trickle charger / conditioner.

Tyres

Inflate the tyres to the normal specifications. See page 35

External

Spray all vinyl and rubber parts (Not Tyres) with rubber preservative.

Spray the unpainted surfaces with a rust preventative spray such as WD40, GT85 or ACF-50 etc. (Not Brake Discs Or Calipers)

Protect the painted surfaces with a good quality car wax.

Procedure for Returning to Service

Clean the entire scooter.

Re-fuel with unleaded fuel.

Re-install the fully charged battery.

Adjust the pressure of tyres as described in the TYRE section. Page 35

Lubricate all places as instructed in this manual.

Do the INSPECTION as listed in this manual before starting or riding the machine.

Specifications

Model	GT/GP125	
Overall size (mm)	1845×670×1115	
Wheel base (mm)	1390	
Kerb/dry weight (Kg)	130	
Max loading weight(kg)	280	
Fuel tank capability (L)	10.5	
Engine model	1P52QMI	
Engine idle speed	1600 ±100 rpm	
Engine type	1 cylinder, horizontal,	
Bore × stroke (mm)	52.4×57.8	
Total displacement (ml)	124.6	
Compression ration	10.5:1	
Max net power, rate (kW/r/min)	7.2/7500 9.2/7000	
Max net torque, rate (Nm/r/min)	376	
Start mode	Electric	
Engine oil(950ml)	SAE 10W/40 Semi	
Lubrication type	Pressure/splash	
Transmission oil 170ml	EP 80w-90	
Fuel type (Unleaded Only)	Octane rating of 94 or higher	
Tyre type		
Front tyre size	110/70-12	
Rear tyre size	120/70-12	
Inflation:		
Front	32 PSI	
Rear	34 PSI	
Front brake	Disc brake	
Rear brake	Disc brake	
Spark plug	NGK CR7HSA	
Head lamp	12V 35/35W or LED	
Turning lamp	12V LED	
Tail lamp/ Brake lamp	12V LED	
Instrument indicator	12V 3W	
Battery capacity	12V 9Ah	
Fuse	10A	
Horn	12V 1.5A, 90-100dB(A)	
Max noise	≤7m ≤82dB(A)	

Warranty

Warranty Terms and Conditions

All Royal Alloy scooters are supplied with a 2 year / 30,000 Kms warranty from the date of registration. Normal wear and tear plus parts required for servicing are excluded.

All service and repair work must use genuine Royal Alloy parts.

It is the end user's responsibility to ensure that the servicing and maintenance schedule is complied with – it may be a matter of importance to book your machine into your dealer for a service well in advance in order to guarantee an appropriate 'slot' for the work to be completed.

The Dealer has a responsibility to record work done to your machine via the Royal Alloy UK online service portal. Your dealer should issue a completed Pre-Delivery Inspection sheet at the time of handing your machine over. Your servicing dealer can also issue you with a copy of the work recorded on the Royal Alloy UK Service Portal – this is your copy of your service history.

The servicing schedule for Royal Alloy scooters is the first service at 500kms or 6 months and then every 3000kms or 6 months whichever comes first.

None Warranty – Excluded Items (except manufacturing Error)

Spark Plug, Fuel Strainers, Oil Filters, Drive Chains, Air Cleaner Elements, Brake Pads, Clutch Disc/Centrifugal Clutch, Light Bulbs, Fuses, Gaskets, Tyres, Grommets, Rubber Hoses, Rubber Cushions, Step Rubber and Drive Belts, Breakdown Recovery, Accidental or Negligent Damage, Oil, Petrol. Corrosion and / or cosmetic deterioration of all components also excluded.

Six Month Limited Warranty Items

Batteries, Side Stand, Main Stand, Seat, Wheel Rim (Distortion), Painted/plated Parts (including Exhaust), Stickers and Emblems.

Twelve Month Limited Warranty Items

Exhaust System Structural failure only (Paint/Rust NOT Included) LED's.

ALL OTHER COMPONENTS AND ASSEMBLIES are covered for the full duration against faulty materials or workmanship, this does not include normal wear and tear, misuse, negligence, accidental damage. If a part or assembly has exceeded its normal lifespan and has simply 'worn out' then this is deemed as a part requiring replacement during normal servicing.

Dealer Responsibility

In order to maintain your Royal Alloy warranty, the supplying dealer must:

- 1.1: Register the bike for warranty on the dealer portal system Moto4parts.
- 1.2: Use genuine Royal Alloy parts for maintaining the vehicle.
- 1.3: Enter the service details carried out, along with observations of the vehicle on the dealer portal system Moto4parts.

Failure to adhere to these conditions may make the servicing dealer responsible for any subsequent warranty claims for the remaining period of the warranty term.

2. Servicing, in order to make a warranty claim, the vehicle must be maintained according to the prescribed maintenance intervals and only genuine Royal Alloy parts may be used. The owner is expected to ensure the execution of the necessary work, and is responsible for the cost of the work and the parts being replaced during periodic maintenance. It is also the owner's responsibility to ensure routine maintenance is carried out in accordance with the maintenance schedule. Failure to service the vehicle at the specified intervals will invalidate the warranty.

3. The warranty is limited to the free replacement or repair of any defective part. This replacement or repair under warranty can only be done with the express permission of dealer.

4. The liability of the manufacturer or importer is limited solely to the warranty as defined in article 3 The buyer can in no way claim or apply for compensation for material or physical damage, consumables or loss of income, transport or accommodation, or vehicle recovery.

5. The warranty is void if: a) The product was not used or maintained according to prescribed maintenance intervals specified in the instructions for the related vehicle. b) The product was repaired or serviced outside the authorised dealer network, or using none original parts. c) Other fuels, lubricants or cleaning products were used than those which were recommended by the manufacturer. d) The product has been rented out or used for commercial purposes. e) A conversion or modification was carried out on the product or if the vehicle has been involved in an accident. f) The product was used for sporting events on closed circuit, off-road, free style, or for purposes for which it was not designed. g) Any alterations to the specification of your machine or the fitting of none standard parts.

6. Normal wear and damage caused by the use of the vehicle and not due to a material or manufacturing fault, are not covered by the warranty: replacement of tyres and tubes, lighting, spark plugs, fuses, rubber parts, brake pads and clutch linings, brake cables, clutch cables, speedometer cables, oil seals, brake discs or drive belts, filters, fluids such as engine oil, coolant, are expressly excluded from warranty coverage. Corrosion or deterioration of all components is also excluded.

7. On plastic parts and body panels they will be guaranteed only if their workmanship or manufacturing defects are detected prior to handover of the new vehicle to the customer.

8. Warranty on batteries is limited to 6 months.

9. Royal Alloy reserves the right to make the final decision on any Warranty Claim.

10. Dealer reserves the right that the images and colours shown are for illustrative purposes Only. Details, prices and specifications are subject to change without prior notice. E & OE.

MEMO:

.....

.....

.....

.....

.....

.....

.....

.....

.....

.....

.....

Owner's Manual



RA Engineering Co., Ltd